

# Iberian Southwest Middle Bronze Age Reading social complexity in greenstone beads from the cist necropolis of Sines

CARLOS P. ODRIEZOLA\*  
JOAQUINA SOARES\*\*  
CARLOS TAVARES DA SILVA\*\*  
PAULO E. FONSECA\*\*\*

## Abstract

The results of chemical and mineralogical analysis of a set of greenstone beads from the Middle Bronze Age cemeteries of Provença and Pessegueiro in the region of Sines (southwest Portuguese coast) showed that these adornments were not made out of variscite, but of raw material available in the geological structure of Serra do Cercal. The regional scarcity of this type of artefacts and its association with gold and silver grave goods in the most qualified burials of both cemeteries allows an inquiry on material expressions of social complexity in the Bronze Age of the southwest of the Iberian Peninsula.

## Keywords

Iberian Southwest Middle Bronze Age; cist necropolis of Provença and Pessegueiro; social complexity; single graves; non-variscite greenstone beads.

---

## 1. Introduction

The presence of body ornaments made from green stones in the western European Late Prehistory has been documented since the 19<sup>th</sup> century in both megalithic tombs and settlements of the Copper Age (e.g. Damour, 1864; Forde, 1930; Ferreira, 1951). A problem arose almost from the very beginning, which still persists today. It came about when the body or-

naments made from green stone were classified as *callaite* or ‘*perles du callais*’. On the one hand is the conceptual confusion that surrounds the term *callaite* – see Vázquez Varela (1975) – and on the other, the issue of placing different minerals under this definition, e.g. variscite, muscovite, serpentinitic/ amphibolitic talc... – see Dominguez-Bella (2012).

---

\* Prehistory and Archaeology Department of the Faculty of Geography and History of the University of Seville.

\*\* MAEDS - Museum of Archaeology and Ethnography of the District of Setúbal; UNIARQ - Center of Archaeology of the Faculty of Letters of the University of Lisbon.

\*\*\* Department of Geology of the Faculty of Sciences, University of Lisbon and IDL – Institute Dom Luiz.

From that point on, little by little, green beads and pendants have been recovered from sites affiliated with different ‘archaeological cultures’ and time periods. Octávio da Veiga Ferreira published the first paper about the distribution in Portugal of prehistoric artefacts made in ‘callaite’ at 1953. In the 1960s, Ana María Muñoz Amilibia drew up a map of ‘callaite’ distribution across the Iberian Peninsula, which back then pertained to the Portuguese (west) and Millarense-Argaric (south-east) settlements and tombs, the Basque megaliths (north) and the Catalan pit graves (north-east); in other words, the outlying areas of the Peninsula (Muñoz Amilibia 1965, fig. 104). Over time, more zones were added, such as the north-west (Gui-tán Rivera and Vázquez-Varela 1975; Fábregas Valcarce 1991, fig. 100), and other inland areas such as the Duero (Campano Lorenzo *et al.* 1985), Guadiana (Odriozola *et al.* 2010), Tagus (Flores 2011; Odriozola *et al.* 2016b), Ebro (Baldellou *et al.* 2012) and Guadalquivir basins (Odriozola and García Sanjuán 2012), La Mancha (Odriozola *et al.* 2016a), Portuguese Alentejo and Estremadura (Odriozola *et al.* 2016c).

A glance at subsequent distribution maps (Villalba *et al.* 2001, fig. 1; Dominguez Bella 2004, fig. 4; Odriozola *et al.* 2010, fig. 1) shows how the gaps have been gradually disappearing, which suggests that the use of green ornaments was a convention that extended across the entirety of Iberia and, as with the megalithic phenomenon and the Maritime Bell-Beaker culture, it transcended regional culture traits during 3<sup>rd</sup> millennium B.C.

To date, most papers devoted to body ornamentation continued to use ‘callaite’ and variscite as synonyms. However, the increase in geochemical analyses of green mineral sources has been paralleled by an increase in the number of analyses of ‘callaite’ beads, and thus in the knowledge of the exact minerals used in beadmaking. Beads have been found to include green mica, chlorite, steatite, turquoise, talc, amphibolite, etc (Villalba *et al.* 2001). As the number of analysed beads increases, it is becoming apparent that Neolithic, Copper Age, and Bronze Age communities used nearly any available green mineral for beadmaking.

In this paper, stone body ornamentation from Provença and Pessegueiro necropolis in Sines

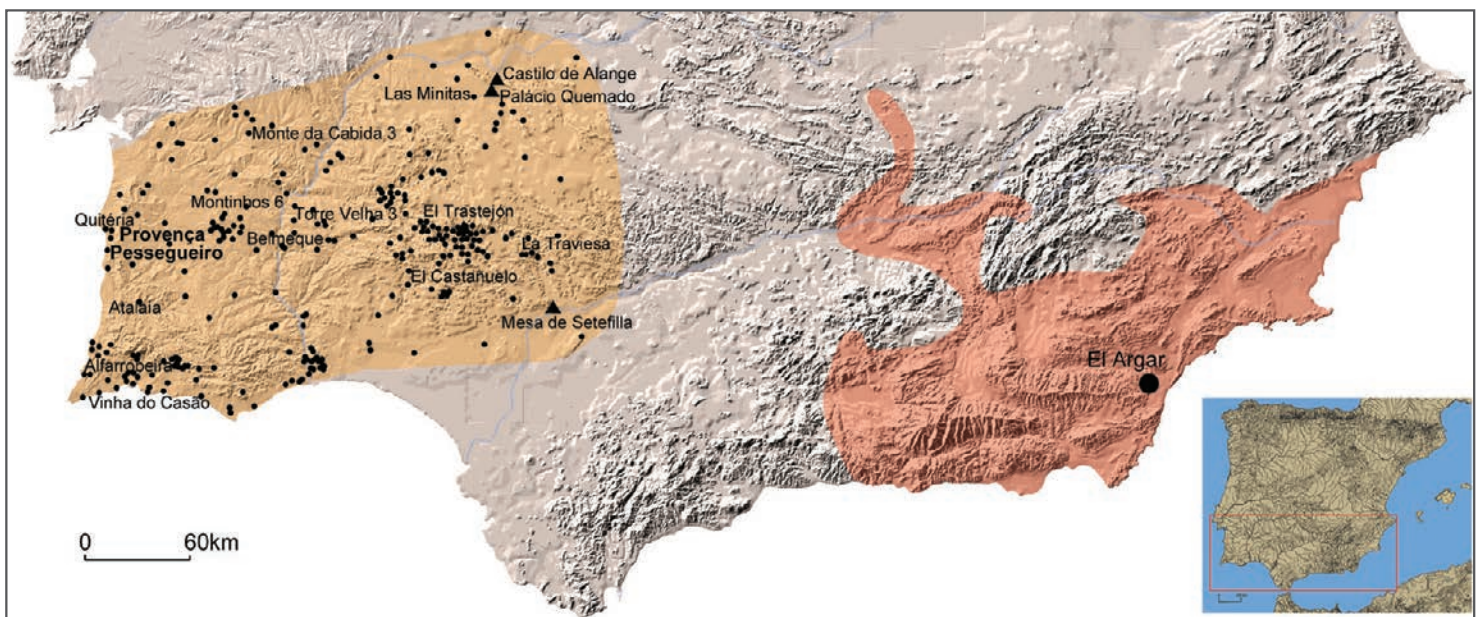

Fig. 1 - Southern of Iberia with the main territories of Southwest Middle Bronze Age Culture (yellow) and El Argar State (red). The most important archaeological sites of the Southwest Middle Bronze Age are located (black). After Soares & Tavares da Silva, 2016.

region (southwest Portuguese coast) will be approached by focusing on raw material characterization, beads chronological and contextual patterning, and social dynamics.

## 2. Archaeological context

### 2.1. The necropolis of Provença

The cist cemetery of Provença is located on a littoral zone, about 7 km south of Sines, and only 1,7 km to the Atlantic shore. The geodesic coordinates of the central point of the necropolis are: 37°55'46.92"N; 8°47'17.69"W (Fig. 1). The site belongs to the parish and municipality of Sines.

The spatial organization of Provença showed two funerary monuments with cist graves, about 100 meters far from each other. Approximately equidistant from them there was a contemporaneous settlement, with perishable architectural features. The western monument was destroyed by mechanical agriculture in 1965. The archaeological excavation of the Monument I (eastern) took place in 1972 (Santos, Soares and Tavares da Silva, 1974, 1975). This monument had 32 small cist graves, but only 28 were preserved. The graves were aggregated in two funerary nuclei about 2 meters apart from each other (Fig. 2).

The cist graves of Provença have a rectangular plan with the exception of the cist 19, with a polygonal shape. The graves were dug in the soil and implanted in the schist bedrock; the walls and the covers were made of schist slabs (from local origin), exception for cist 15, whose walls were made in dunar consolidated sandstone, available in the nearby S. Torpes bay, and the lid of cist 1 that was carved in ferruginous sandstone. Each grave was protected and monumentalised by a *tumulus* with a rectangular outline engirdled by small raised schist slabs; *tumuli* were constituted by clayey sediment containing pottery sherds and stone blocks. Inside the *tumulus* of cist 1, two complete ceramic vessels were recovered. The *tumuli* enclosures are connected to each other and sometimes interpenetrate, forming a type of aggregate honeycomb, which de-

veloped from the founder grave.

The larger graves and *tumuli* were constructed with an approximate north-south orientation and form the earlier core of Monument I. In the more recent graves the longest axis were preferably positioned east-west. In general, the dimensions of the cist rarely exceed 1 m in length; both its width and depth measure about 0.50/ 0.60 m.

The funerary ritual, as occurred in the other cemeteries of the Iberian Southwest Middle Bronze Age, was characterized by individual burials where the body was deposited in crouched position and in lateral decubitus, in an aerobic atmosphere. In fact, sediments did not usually cover the bodies and the grave goods, although over time soil would have infiltrated the chambers. Some of the cists could be reused sequentially for single depositions.

At the cemetery of Provença the occurrence of edaphic and chemical unfavourable post-depositional conditions did not allowed the preservation of the bone remains; only small fragments have been found. Therefore, these findings did not give sufficient anthropological information nor enough collagen could be collected for radiocarbon chronology.

Many of the burials had no grave goods, not even revealing signs of perturbation; some contained only a small ceramic vessel; in fact, cist 23, which was sealed by a lid, provided only one fragment of a vessel (Santos, Soares and Tavares da Silva, 1974 Fig. 2), which seems to prove the mere symbolic nature of this deposit; on contrary, the cist 12, on the northern periphery, contained a rich offerings, well differentiated from the other burials (Fig. 5).

#### 2.1.1. Cist 12

The cist 12 is located in the northern periphery of the southern nucleus of the monument I. It is integrated in a *tumulus* with rectangular plan, measuring 2,20m x 1,20m. The southern side of this *tumulus* connects the enclosure of the severely damaged cist 29; to the east, it is confined by the *tumulus* of cist 13, and to the west, by the enclosure of the cist 23.



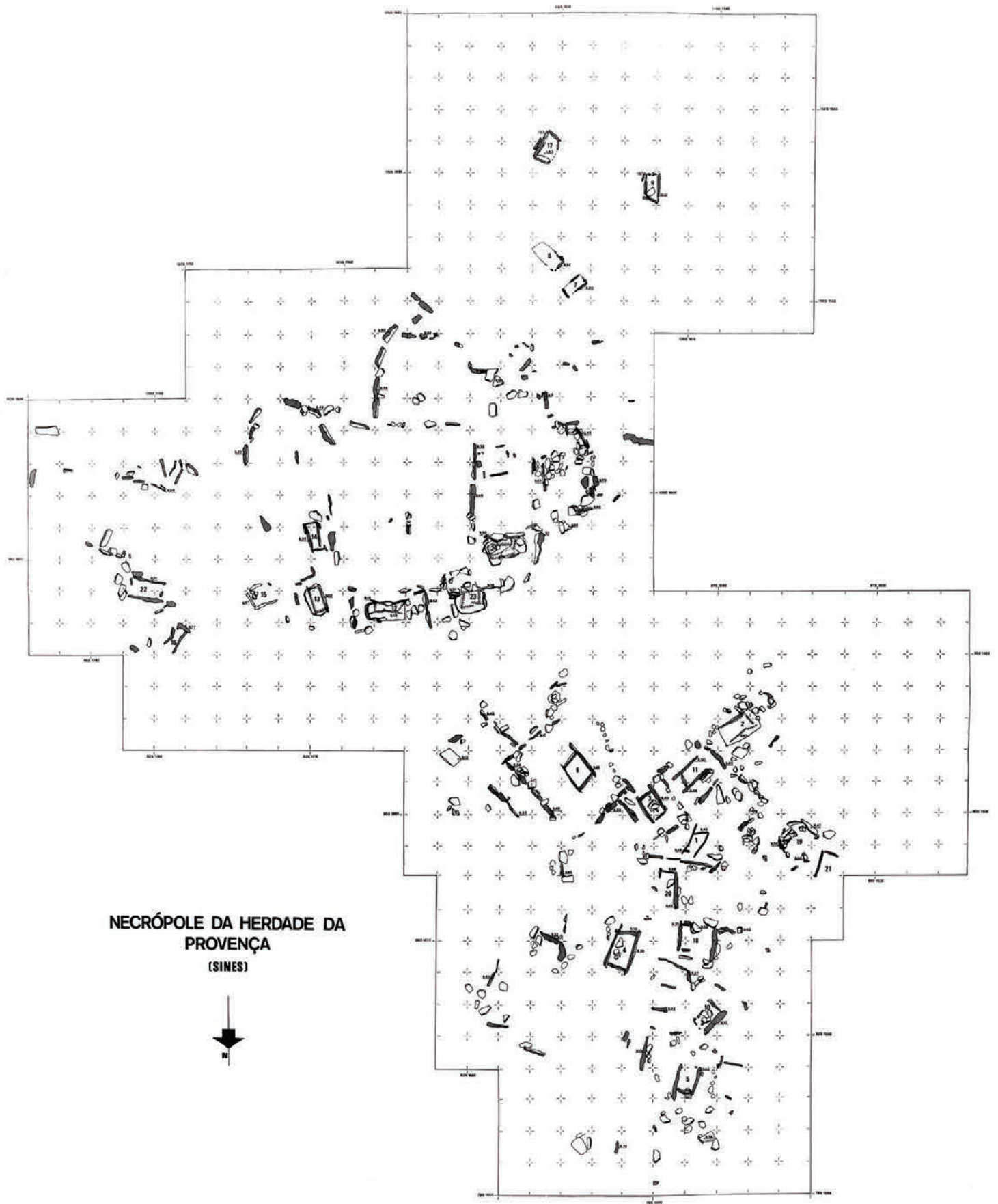

Fig. 2 - Plan of the Monument I of the necropolis of Provença (Sines). After Tavares da Silva and Soares, 1981.

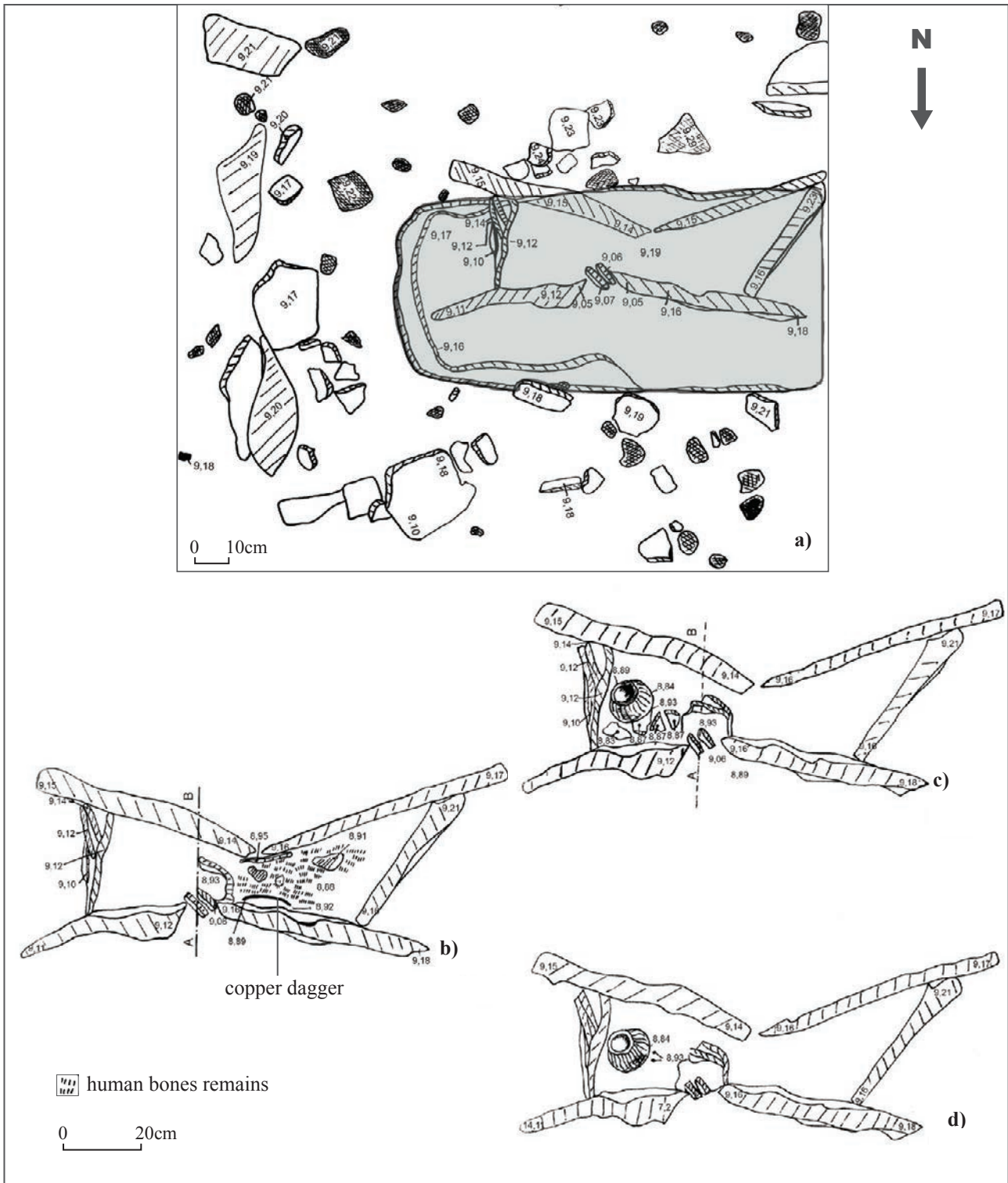

Fig. 3 - Field drawings of the plans from the last burial in cist 12 (cemetery of Provença): a) grave with lid and *tumulus* remains; b) the appearance of the arsenical copper dagger; c) plan with the ceramic vessel with strangled neck; d) ceramic vessel, greenstone and gold beads. After Tavares da Silva and Soares.



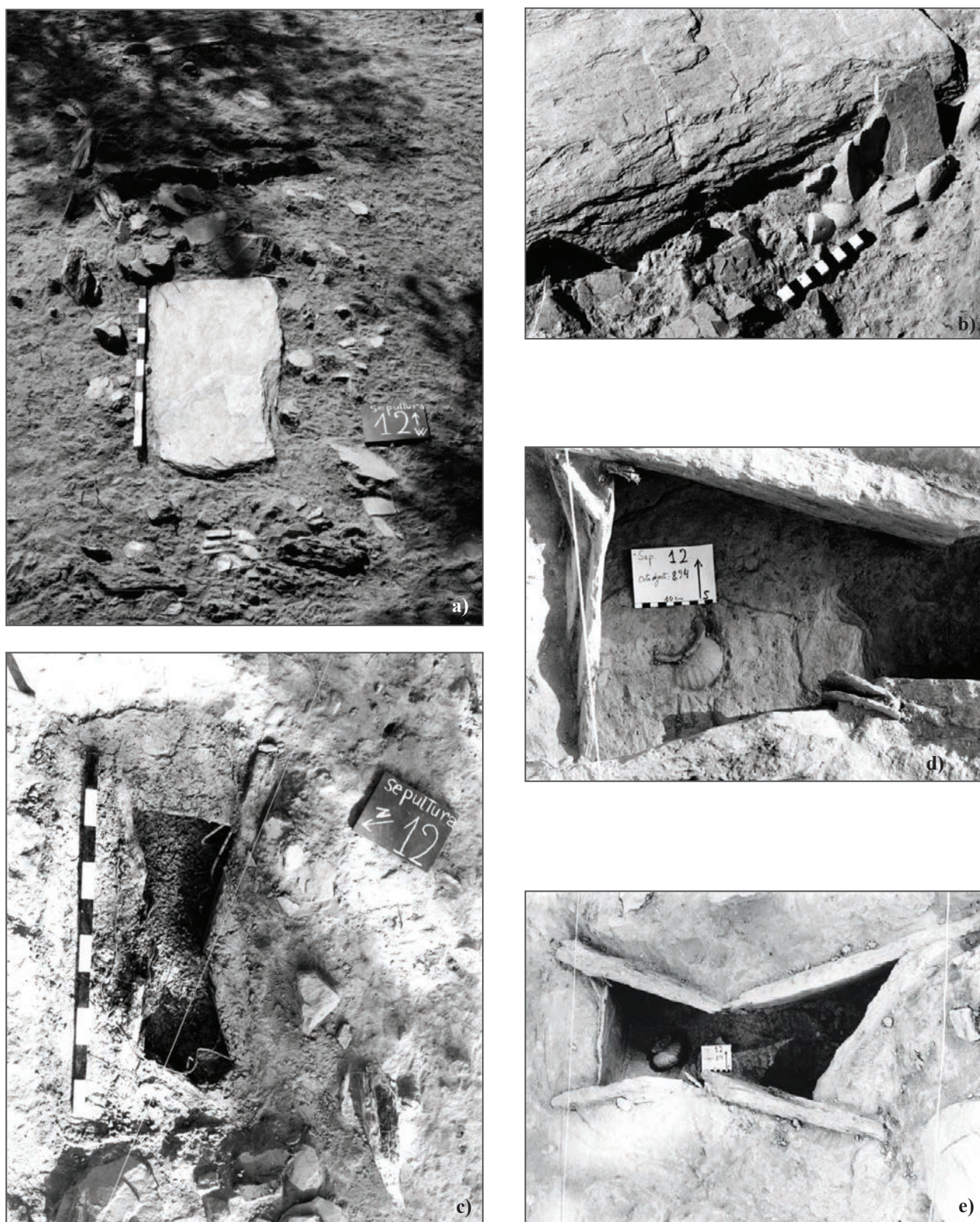

Fig. 4 - Cist 12 of the cemetery of Provença (Sines). Sequential phases of the excavation. Photograph by Carlos Tavares da Silva.



The grave's longest axis was positioned east west. A rectangular monolithic lid in schist that measures 1,25m in length, 0,56m in width and 0,07m in its maximum thickness covered the cist (Figs. 3a and 4a). Sediments did not fill the cist 12, as others (Fig. 4c); its original rectangular plan was deformed; the lateral wall slabs, inserted into the bedrock, had been fragmented by external pressures, although the existence of an interior reinforcement. The funerary chamber measured 1,20m in length, 0,43m in width and 0,50m in depth. Over the lid, remains of the *tumulus* were found constituted by clayey sediment with pebbles, schist blocks and some ceramic sherds (Fig. 4b).

Cist 12 contained two sequential burials. From the first funerary deposition, human remains were not preserved, but a small low carinated bowl, in a normal position, was recovered; The last burial of this grave, separated from the former by a schist slab, contained very small fragments of human bones, and a rich set of grave goods constituted by:

- An arsenical copper dagger with rivets deposited along the northern wall slab; the blade was pointed to the east, what fits well with a crouched inhumation in lateral decubitus oriented east (head) – west, and facing the north;
- A globular ceramic vessel with a vertical strangled neck and extroverted rim, smoothed and burnished walls, fired in reducing conditions, decorated by lobes. It had been deposited in a normal position, probably between the hands and the chest of the deceased (Figs. 3c, d and 4d, e). Mário Varela Gomes (2015, p. 86) suggested that the shape of such prestigious container could be inspired by the opium poppy (*Papaver somniferum* L.). This is an interesting hypothesis, but needs further research, namely analysis of consumption traces.

Close to the bottom of the ceramic vessel there was a spiral gold bead and two beads carved in green stone, with a discoid shape and a central cylindrical perforation (Tavares da Silva and Soares, 1981), subject to chemical and mineralogical analysis presented in this paper.

The absence of enough collagen in the hu-

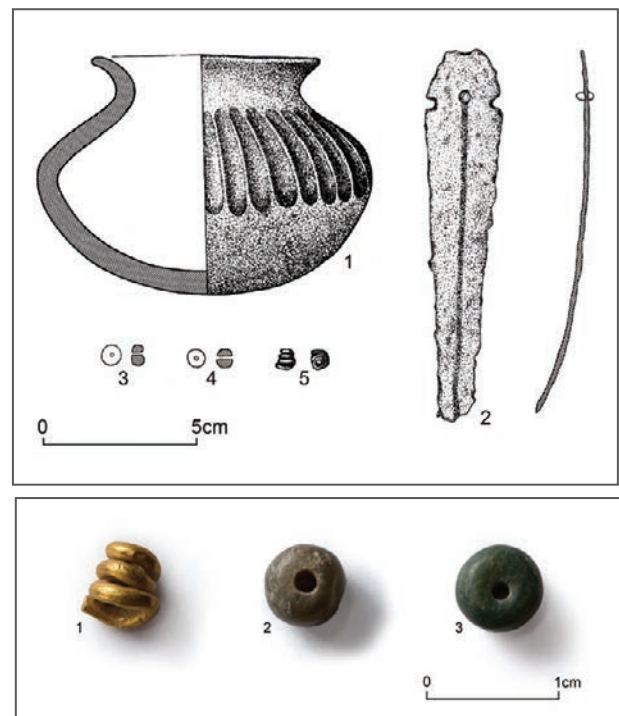

Fig. 5 - Necropolis of Provença, cist 12. Grave goods from the last burial: 1 - ceramic vessel; 2 - arsenical copper dagger; 3, 4 - greenstone beads; 5 - gold spiral. After Tavares da Silva and Soares, 1981.

man bones fragments did not allow a radiocarbon analysis. Nevertheless, this burial can be dated by the small-strangled neck pot, a characteristic funerary pottery type from the late phase of the Middle Bronze Age of the Iberian Southwest (Schubart, 1975). The Belmeque hypogeum at Serpa (Alentejo) was radiocarbon dated by a sample of human bones - ICEN-142: 3230±60 BP, 1660-1400 cal BC, 2 sigma (Soares, 2004); among the burial offerings there was a ceramic vessel belonging to the same typological group.

## 2.2. The necropolis of Pessegueiro. Monument II

The necropolis and the settlement of Pessegueiro are located in a littoral zone, close to the sandy beach of Pessegueiro, that belongs of the municipality of Sines and to the parish of Porto Covo. The centre of the necropolis has the following geodesic coordinates: 37°49'59.92"N; 8°47'10.53"W (Fig. 1).

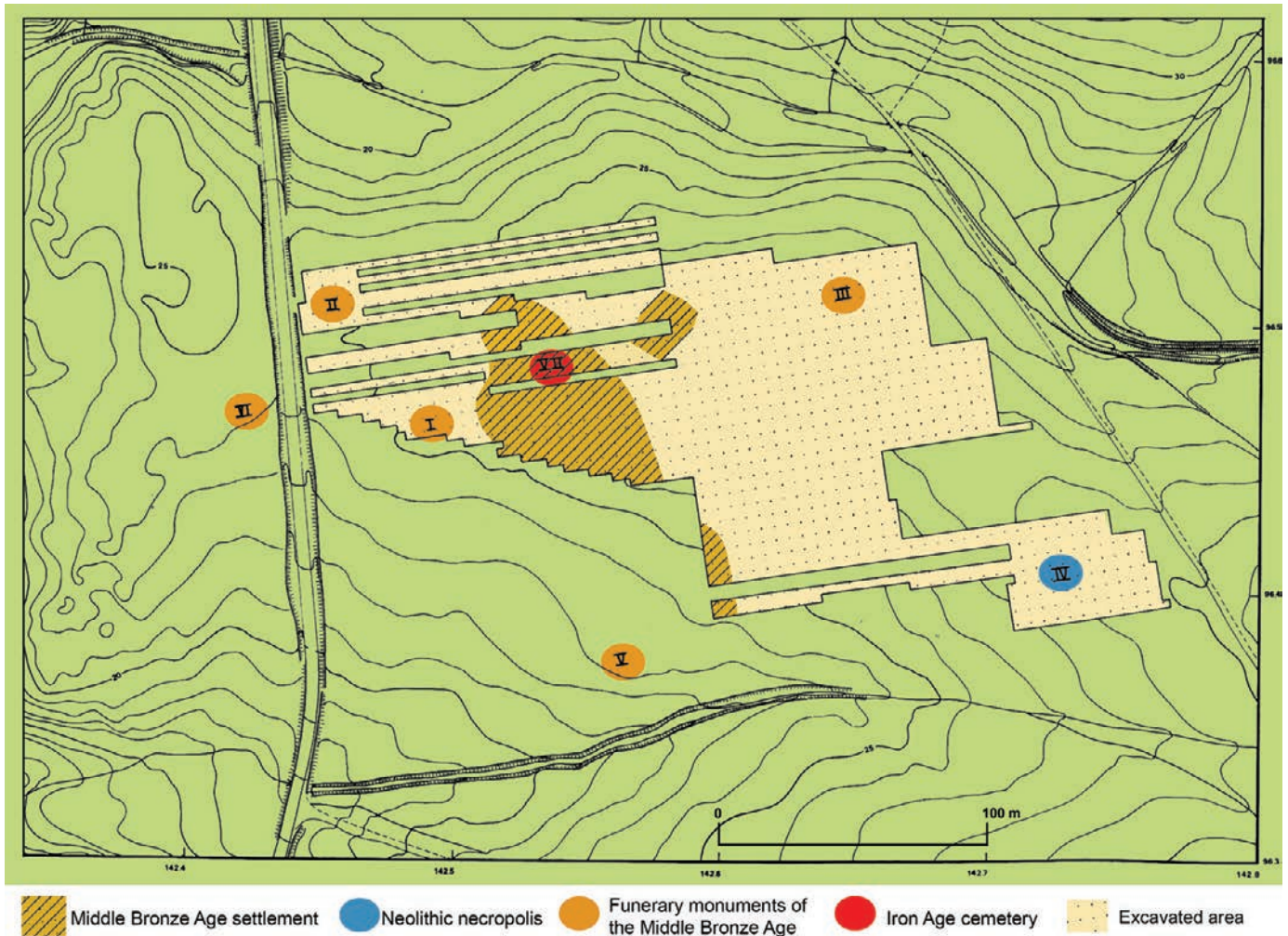

Fig. 6 - Pessegueiro. Excavated area. After Tavares da Silva and Soares, 2009.

This archaeological site is situated on a sandy plain with about 1 ha, limited by two small streams that converge in the Corgo do Pessegueiro. The geological substratum is constituted by Plio-Pleistocene sandstone.

The settlement has about 0,5 ha. Its stratigraphy revealed one single occupation contemporaneous of the necropolis. Several domestic structures had been recovered, just as fireplaces, postholes, cobbled pavements and wall foundation alignments of small raised schist slabs; huts had rectangular plans, and were built mostly out of perishable materials (Tavares da Silva and Soares, 1981).

The cemetery is constituted by at least five monuments (Fig. 6) adjacent and surrounding the inhabited area.

The beads studied in this paper came from the cist 1 of the Monument II (Figs. 7, 8). This oval shaped monument is about 16m in its largest axis, with an east-west direction, and 14m in its north-south axis; it is located only 50 m far from the settlement and is formed by 27 graves of small stone cists type with a rectangular plan. Monument II can be desegregated into four nuclei of stone cists, probably related with the kinship structure of the Pessegueiro community; each grave was built with four slabs



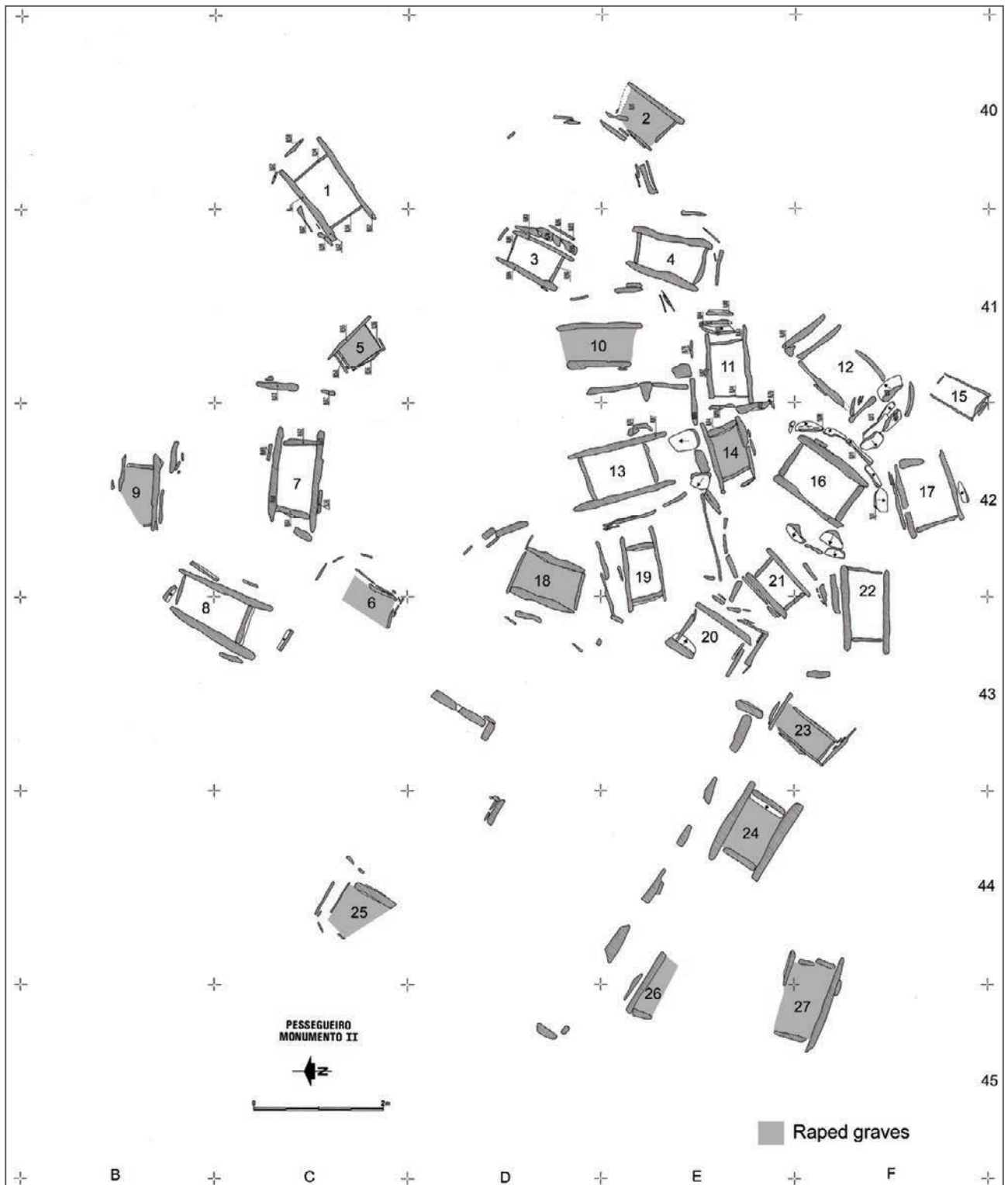

Fig. 7 - Plan of the Monument II of the necropolis of Pessegueiro (Sines). After Tavares da Silva and Soares, 2009.

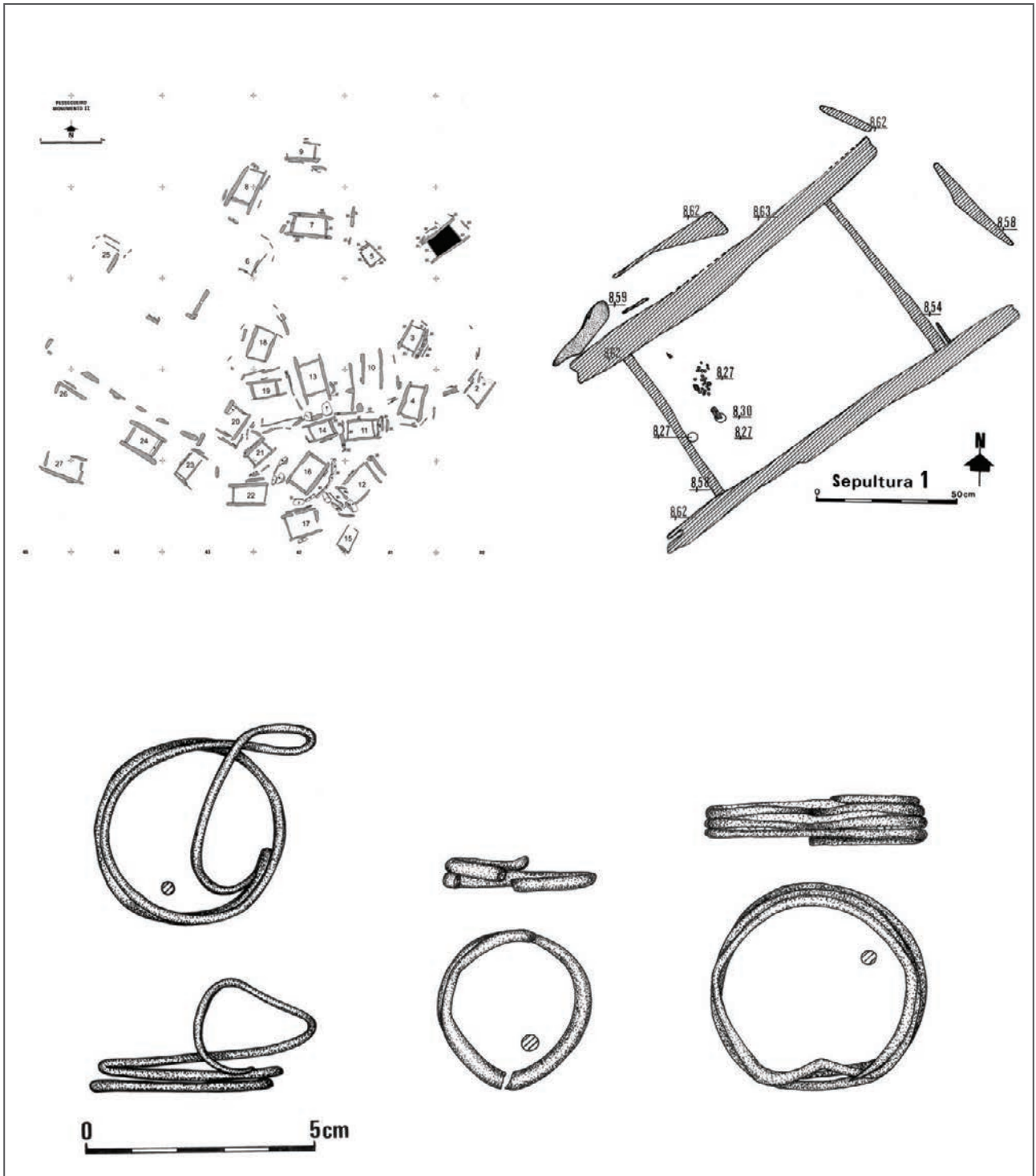

Fig. 8 - Monument II of the necropolis of Pessegueiro (Sines). Plan of the cist 1 and silver spirals from it. After Tavares da Silva and Soares, 2009.



of schist and/or dunar sandstone, and covered by a monolithic lid. The grave was positioned inside an enclosure also with rectangular plan defined by small raised stone slabs that contained the *tumulus* for protecting and monumentalising the ancestor's memory. These funerary enclosures were linked, raising a complex network with a honeycomb like shape, commanded by the founder's grave. Furthermore, each *tumuli*, by symbolic reasons or practical convenience, included sediments probably from the settlement, indicated by small fragments of numerous domestic ceramic vessels (Tavares da Silva and Soares, 2009).

Only cist 16 (nucleus C) gave anthropological remains, in which two individuals were buried at different moments. The former was a male adult approximately 30 years old at the time of the burial. However, later on, the grave was reused and the previous human remains were rearranged close to one of the lateral slabs inside the grave. In the later burial a female corpse was found in a foetal and right lateral decubitus position with the head pointing towards northeast; she was about 35-45 years of age and about 150 cm tall; considering categorisation, they both belong to the Mediterranean gracile subtype (Tavares da Silva and Soares, 2009, p. 403; Fernandes, 2009). The radiocarbon chronology of this grave had been obtained by two determinations on the human bones from both individual burials. Earlier inhumation: ICEN-867: 3270±45 BP (1679-1442 cal BC, 2 sigma); later inhumation: ICEN-868: 3030±40 BP (1407-1131 cal BC, 2 sigma) (Soares and Tavares da Silva, 2016).

In what concerns the grave goods of Monument II only seven cists had preserved artefacts accompanying the deceased; three of them contained one ceramic vessel; two graves had a ceramic vessel and a copper awl; one cist held a ceramic recipient and a long copper dagger; the grave goods of cist 1 from nucleus A, subject of the present study, was composed by three silver spirals and 23 stone beads (Fig. 8); 7 graves had no offerings and the remaining

13 graves were emptied before our intervention.

The hierarchical spatial organization inside the necropolis, the architecture of the tombs, the grave goods typology and the mortuary ritual of Monument II indicate a very unequal local society from a later phase of the Middle Bronze Age.

### 2.2.1. Cist 1

Cist 1 is located in the periphery of nucleus A; it has a rectangular plan, and its main axis was oriented northeast-southwest. This stone cist measures (interior): 0,92m in length, 0,65m in width and 0,49m in depth. The grave had been built with schist slabs. The lid disappeared before the archaeological excavation (Fig. 7). The *tumulus* connects with that of grave 5.

Three silver spirals appeared next to the minor side (south-western) of the grave, together with 23 perforated stone beads: 20 with sub spherical shape, a central cylindrical perforation (4 to 6 mm in diameter) and green colour; 2 with sub spherical shape (6 to 9mm in diameter) and pinkish white color; 1 with sub cylindrical shape and brown colour. Dimensions: 11mm in diameter and 17mm in thickness (Figs. 9, 10, 11).

## 3. Materials and Methods

The mineralogical identifications of beads in this paper (24 samples from the sites of Provença and Pessegueiro II in Sines, Portugal) are based on the chemical composition measured by an Oxford Instrument XMET-7500 portable energy dispersive x-ray spectrometer (EDX) with an Rh tube, a silicon drift detector (SDD), and an automatic 5-position filter changer. Quantification was obtained with the SOILS-LE program.

Beads have been labelled in the order the bracelet was set in the Museum of Archaeology and Ethnography of the District of Setúbal

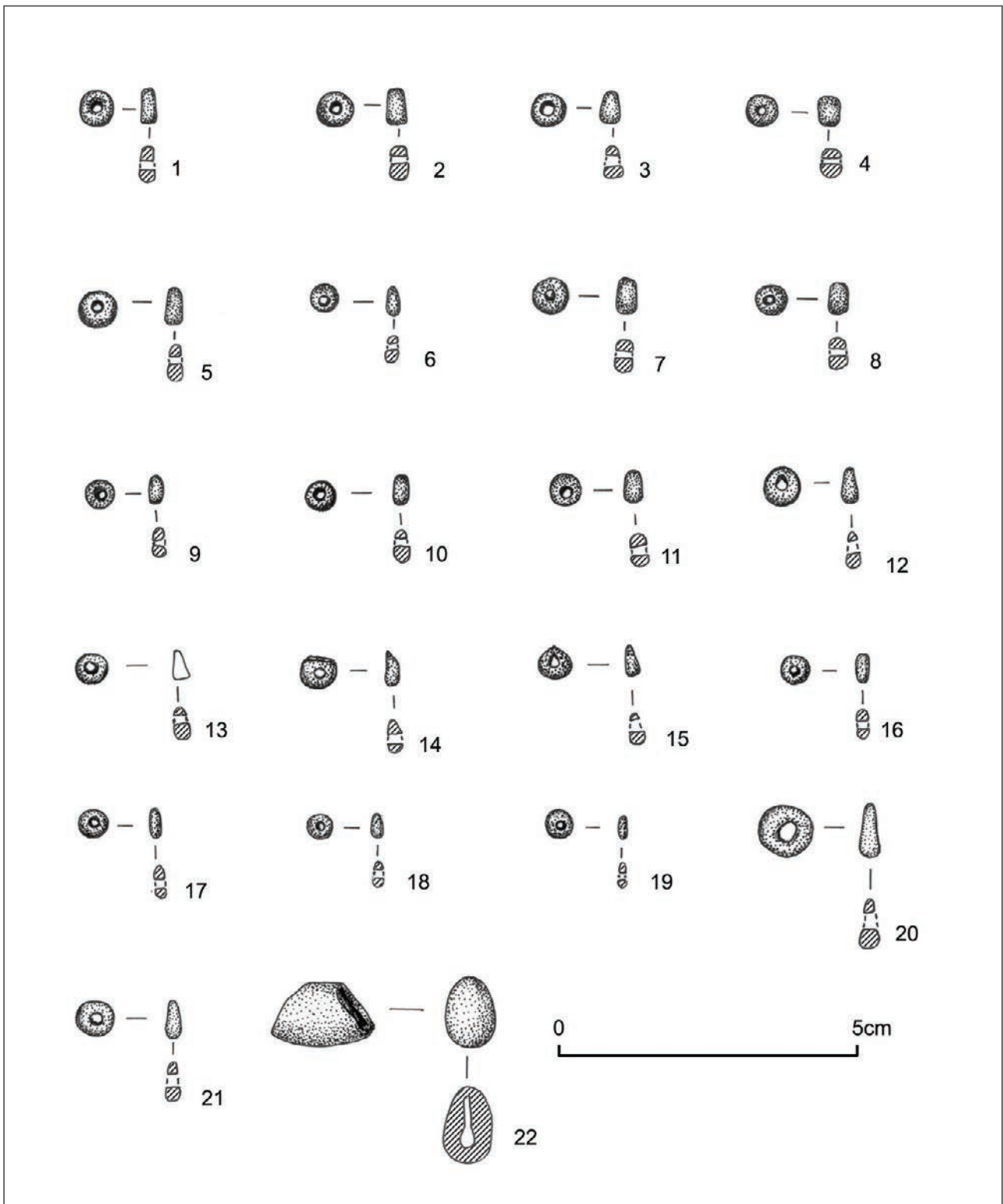

Fig. 9 - Monument II of the necropolis of Pessegueiro (Sines). Greenstone beads from cist 1. After Tavares da Silva and Soares, 2009. Correspondence with Fig. 10: 1 - Pes 7; 2 - Pes 6; 3 - Pes 13; 4 - Pes 19; 5 - Pes 9; 6 - Pes 20; 7 - Pes 8; 8 - Pes 15; 9 - Pes 18; 10 - Pes 17; 11 - Pes 5; 12 - Pes 16; 13 - Pes 2; 14 - Pes 4; 15 - Pes 14; 16 - Pes 21; 17 - Pes 22; 18 - Pes 3; 19 - Pes 1; 20 - Pes 10; 21 - Pes 12; 22 - Pes 11.



Fig. 10 - Beads assemblage of cist 1 of Monument II of the necropolis of Pessegueiro (Sines). All beads are scaled. Photograph by Carlos P Odriozola.



(S.E.M./10030\_10051), that is with the biggest bead in the middle and the shorter ones in the ends –see photograph (Fig. 10).

#### 4. Results

EDX analysis (Table 1) of the 22 beads from Pessegueiro II tomb 1 are compatible with the chemical composition of green micas, e.g. muscovite, except for samples 11 and 13. Both samples, 11 and 13, have a high Mg value which makes their chemical composition compatible with that of biotite/phlogopite mica type and/or chlorite.

The most common green stones shaped into beads in prehistoric Iberia are variscite, mica, talc-steatite, chlorite and serpentine – *chrysotile*, *antigorite* and *lizardite*. The mineralogical classification of beads by means of portable analytical devices is not a straightforward task and deserves a full-length paper in its own right. However, differentiating between green stone types formed by sheet silicates (micas, talc-steatite, chlorite or serpentine), although

possible is a highly complicated task.

Micas have a Si-to-Al ratio that ranges from 1-3 depending on the type of mica: muscovite  $[KAl_2(OH,F)_2AlSi_3O_{10}]$ , biotite  $[K[Mg,Fe]_3(OH,F)_2AlSi_3O_{10}]$  and phlogopite  $[KMg_3(OH,F)_2AlSi_3O_{10}]$  have K and a variable amount of  $M^{+2}$  substitutions (Mg, Fe) (Roberts *et al.*, 1990; Deer *et al.*, 1992). Chlorites  $[A_{4-6}Z_4O_{10}(OH)_8]$ , where  $A = Al, Fe^{2+}, Fe^{3+}, Li, Mg, Mn^{2+}, Ni; Z = Al, B, Fe^{3+}, Si]$  (Roberts *et al.*, 1990; Deer *et al.*, 1992), have a Si-to-Al ratio ranging from c. 1.7-8 and a variable amount of Fe, Mg and Mn. To differentiate between these two aluminosilicates we look at the Si-to-Al atomic ratio and the amount of Fe, Mg and K.

Si-to-Al ratio in all samples, except of sample pes11, ranges from 0.9 to 1.3 which make these samples compatible with the Si-to-Al ratio of muscovite type micas. In addition to this, substitutions of  $Al^{+3}$  for  $Fe^{+3}$  ions may occur in this mica type mineral what allows for atomic concentration values of  $Fe^{+3}$  of  $0.76 \pm 0.24\%$ .

The amount of Mg recorded from sample pes13 together with the recorded K makes the

Table 1 - EDX analysis with the chemical composition of the greenstone beads from Monument II of Pessegueiro and Provença necropolis expressed as percentage of atoms.

SITE	Míneral	Mg	Al	Si	S	Cl	K	Ca	Ti	V	Cr	Mn	Fe	Co	Cu	Zn	Rb	Sr	Zr	Ba	Height	Width	Perforation	Weight	L	C	h
Pessegueiro	mica	0,00	47,06	41,80	0,16	1,57	8,00	0,32	0,109	0,000	0,056	0,000	0,879	0,000	0,001	0,000	0,009	0,015	0,001	0,016	2,05	4,37	1,19	0,05	61,00	19,42	124,50
Pessegueiro	mica	0,00	45,07	41,76	0,24	1,89	9,90	0,10	0,128	0,000	0,083	0,000	0,792	0,000	0,000	0,000	0,012	0,010	0,000	0,010	2,47	4,43	0,92	0,07	50,00	19,79	149,50
Pessegueiro	mica	0,00	45,54	41,62	0,17	1,72	9,71	0,10	0,112	0,213	0,000	0,000	0,786	0,000	0,000	0,000	0,012	0,008	0,000	0,013	1,87	4,57	1,12	0,07	37,00	7,21	146,30
Pessegueiro	mica	0,00	45,91	43,11	0,18	2,01	7,23	0,56	0,067	0,000	0,023	0,000	0,841	0,000	0,000	0,000	0,011	0,020	0,000	0,038	2,96	5,21	1,17	0,12	62,00	12,53	118,60
Pessegueiro	mica	0,00	41,67	45,88	0,17	1,28	9,73	0,16	0,082	0,000	0,110	0,000	0,887	0,000	0,000	0,000	0,011	0,009	0,000	0,015	3,79	5,58	1,16	0,19	61,00	15,65	153,40
Pessegueiro	mica	0,00	41,16	46,74	0,20	2,00	8,68	0,08	0,155	0,000	0,034	0,000	0,912	0,000	0,000	0,000	0,009	0,003	0,000	0,022	2,85	6,14	1,54	0,18	60,00	17,49	120,96
Pessegueiro	mica	0,00	47,39	40,60	0,19	1,76	8,80	0,22	0,107	0,000	0,038	0,000	0,813	0,000	0,003	0,000	0,013	0,016	0,000	0,038	3,90	5,91	0,72	0,23	57,00	14,32	155,22
Pessegueiro	mica	0,00	44,30	43,44	0,17	1,24	9,41	0,15	0,103	0,000	0,249	0,000	0,884	0,000	0,005	0,000	0,012	0,010	0,000	0,030	3,62	6,03	0,94	0,20	54,00	24,21	141,71
Pessegueiro	mica	0,00	42,70	43,56	0,10	0,86	11,35	0,15	0,158	0,000	0,000	0,000	1,066	0,000	0,002	0,000	0,007	0,002	0,000	0,037	2,34	6,25	1,36	0,11	59,00	13,89	120,26
Pessegueiro	mica	0,00	41,75	42,96	0,20	1,23	12,56	0,54	0,170	0,000	0,000	0,000	0,553	0,000	0,000	0,000	0,009	0,009	0,000	0,018	2,66	7,70	3,69	0,18	62,00	35,74	72,07
Pessegueiro	mica	0,00	45,86	41,89	0,16	1,15	10,57	0,13	0,124	0,000	0,000	0,000	0,077	0,000	0,000	0,000	0,012	0,003	0,004	0,011	2,51	6,34	1,64	0,16	66,00	36,69	72,55
Pessegueiro	mica	13,97	33,55	30,28	0,14	1,34	0,00	0,31	0,057	0,000	0,000	0,361	19,591	0,000	0,337	0,029	0,002	0,000	0,000	0,020	3,48	5,94	1,92	0,21	46,00	1,00	90,00
Pessegueiro	mica	0,00	45,99	41,78	0,13	1,23	9,58	0,13	0,119	0,000	0,060	0,000	0,915	0,000	0,014	0,000	0,013	0,013	0,000	0,020	2,35	6,01	1,97	0,11	35,00	18,79	115,20
Pessegueiro	mica	0,00	45,34	43,17	0,13	1,34	9,05	0,16	0,100	0,000	0,000	0,000	0,642	0,000	0,003	0,000	0,015	0,017	0,000	0,035	2,55	5,40	1,26	0,14	55,00	19,92	107,53
Pessegueiro	mica	0,00	43,21	42,67	0,25	1,86	9,86	0,26	0,148	0,000	0,064	0,000	1,567	0,000	0,067	0,000	0,012	0,011	0,000	0,031	2,78	5,61	1,20	0,13	46,00	17,09	110,56
Pessegueiro	mica	0,00	46,26	42,45	0,12	1,18	8,69	0,23	0,173	0,000	0,036	0,000	0,787	0,000	0,000	0,000	0,010	0,030	0,000	0,031	3,44	5,41	0,97	0,16	44,00	21,21	135,00
Pessegueiro	mica	0,00	46,40	41,68	0,13	1,42	9,34	0,08	0,086	0,000	0,061	0,000	0,752	0,007	0,002	0,000	0,011	0,009	0,000	0,020	2,49	5,09	1,32	0,11	42,00	20,62	140,91
Pessegueiro	mica	0,00	46,52	41,62	0,13	1,24	9,49	0,05	0,082	0,203	0,000	0,000	0,642	0,000	0,000	0,000	0,011	0,009	0,000	0,013	2,20	4,91	0,98	0,09	42,00	8,54	159,44
Pessegueiro	mica	0,00	46,82	40,86	0,17	1,84	9,09	0,12	0,140	0,000	0,035	0,000	0,862	0,000	0,000	0,000	0,013	0,014	0,000	0,029	3,01	4,69	0,87	0,11	41,00	17,69	132,71
Pessegueiro	mica	0,00	46,55	40,23	0,25	1,77	9,92	0,18	0,151	0,000	0,073	0,000	0,841	0,000	0,000	0,000	0,011	0,010	0,000	0,014	1,69	4,51	0,41	0,07	54,00	17,69	132,71
Pessegueiro	mica	0,00	43,96	41,55	0,19	1,75	11,12	0,11	0,101	0,000	0,168	0,000	1,045	0,000	0,000	0,000	0,008	0,002	0,000	0,000	1,22	4,00	0,00	0,00	53,00	20,00	143,13
Provença	mica	0,00	40,02	46,24	0,28	1,54	9,96	0,21	0,103	0,000	0,019	0,000	1,575	0,000	0,000	0,000	0,012	0,011	0,000	0,019	5,67	6,29	1,53	0,32	34,00	19,65	104,74
Provença	mica	0,00	44,15	43,40	0,14	1,10	9,49	0,24	0,230	0,000	0,123	0,000	1,074	0,000	0,000	0,000	0,012	0,017	0,004	0,027	4,60	6,61	1,09	0,33	35,00	16,97	135,00
Pessegueiro	talc	42,56	2,73	52,75	0,08	0,71	0,00	0,34	0,028	0,000	0,000	0,009	0,700	0,000	0,086	0,000	0,000	0,001	0,000	0,000	16,86	11,48	2,32	2,00	14,00	15,00	36,87



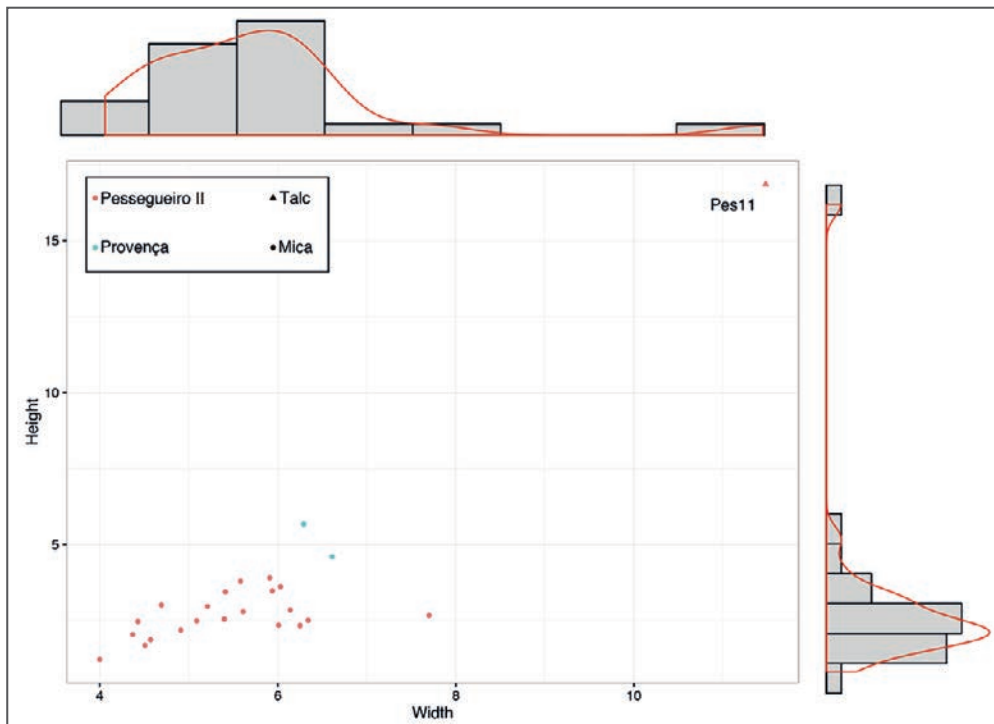

Fig. 11 - Beads' width vs. height plot (measurement unit mm).

chemical composition of this sample compatible with the chemical composition of black micas, e.g. biotite, and incompatible with chlorite, talc or serpentine, as neither of this mineral accounts for K on its constituents. In addition to this, the colour of the bead is black, what is in agreement with its classification as black mica (biotite).

Mg values for sample pes11 are way too high to make its chemical composition compatible to that of the mica family minerals. This together to its Al value, 1.29%, makes its chemical composition compatible with that of chlorites. However, its Si-to-Al ratio (20.1) is high above the upper threshold for chlorites (8). Therefore, the small amount of aluminium and the high content on magnesium and silica makes its chemical composition compatible with that of serpentines and talc derived from ultramafic lithologies.

Serpentine  $[A_3Si_2O_5(OH)_4]$ , where A = Mg,  $Fe^{2+}$ , Ni (Roberts *et al.* 1990), and talc  $[Mg_3Si_4O_{10}(OH)_2]$  (Roberts *et al.* 1990; Deer *et al.* 1992) are magnesium silicates and have no or small amounts of aluminium, thus the Si-to-Al atomic ratio should clearly differentiate these minerals

from the former. However, to differentiate between them we should again look at the Si-to-Al atomic ratio because serpentines have no Al, whereas talc may have Al substitutions in small quantities. The quantity of Mg and Fe also contributes to differentiate between these two minerals, as talc tends to have more Mg and Fe than serpentine.

To this point pes11 sample's chemical compositions seems to be compatible with that of talc due to its low aluminium content, absence of potassium and high content of silica and magnesium. Although neither pes11 nor the other samples mineralogical identification can be assured unless x-ray diffraction or any other mineralogical characterization technique is applied.

It happens that muscovite type micas colour is white to colourless, but it can be tinged various colours by impurities. Samples pes10 and pes12 are of a yellow pale colour that means that it presents some compositional differences with the greener hues muscovites. These hue differences may derive from the fact that these two samples do not account for Cr and accounts for less Fe than

Fig. 12 - LCh color space coordinates plot (C,h°).

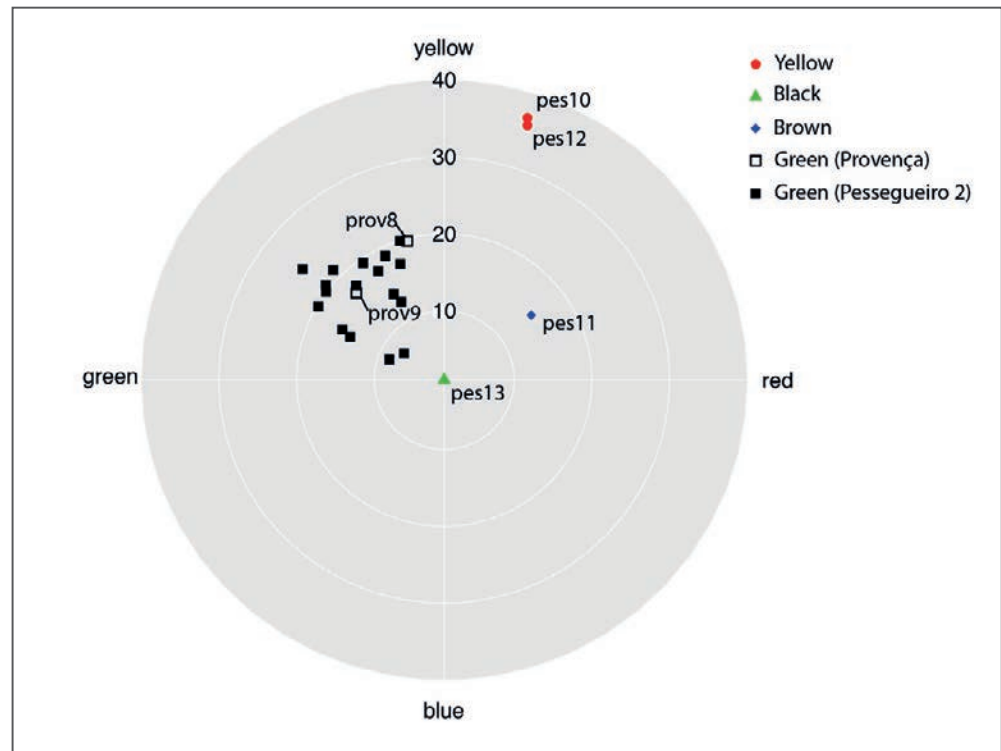

the greener hues. Both, Cr and Fe, are believed to be responsible for the green colour.

As for Pessegueiro (Table 1) II EDX analysis of the 2 beads from Provença are compatible with chemical composition of green micas. They have, indeed almost identical chemical composition to the 21 beads from Pessegueiro II that have

been identified as micas.

To this extent, sample pes11 seems to be made of a different raw material; green mica or most likely talc derived from ultramafic rock probably a weathered dunite. However, this is not the only difference between this bead and the assemblage. Bead pes11 also has differences in colour

Table 2 - Radiocarbon available dates for green mica beads.

Lab code	Site	Years BP	Years BP SD	Column1	Years cal BC	Reference
Beta-68667	Castillo de Alange (c/ Umbria 3/ N. II)	3080	90	1518	1056	(Pavón Soldevila, 1994)
KIA-18997	Fuente Álamo (tomb 11)	3470	25	1878	1698	PINGEL V. (2004)
KIA-18998	Fuente Álamo (tomb 112)	3165	27	1497	1406	PINGEL V. (2004)
OxA-4971	Fuente Álamo (tomb 52)	3610	50	2133	1782	PINGEL V. (2000)
OxA-4973	Fuente Álamo (tomb 75)	3635	50	2137	1887	PINGEL V. (2000)
OxA-4972	Fuente Álamo (tomb 75)	3545	65	2110	1692	PINGEL V. (2000)
OxA-5047	Fuente Álamo (tomb 90)	3435	55	1883	1625	PINGEL V. (2000)
Beta-142035	Las Minitas (tomb 15)	3430	50	1886	1640	(Pavón Soldevila, 1994)

PINGEL V. (2004): "Radiocarbonfür die Graber 111 und 112 sowiezu den Siedlungsbefunden am Südhang von Fuente Álamo", Madrider Mitteilungen 45, pp. 80-87.

PINGEL V. (2000): "Dataciones radiocarbónicas de Fuente Álamo 1977-1991", Fuente Álamo. Las Excavaciones Arqueológicas (1977-1991) en el Poblado de la Edad del Bronce, (Schubart, H., Pingel, V. y Arteaga Matute, O., editors), Junta de Andalucía, Sevilla, pp. 91-98.

Pavón Soldevila, I., 1994. El mundo funerario de la edad del bronce en la Tierra de Barros: una aproximación desde la bio-arqueología de Las Minitas. Mem. Campaña Urgenc. De 2008-141.

and shape (Table 1, Fig. 12).

We have recorded the height, width, perforation diameter and weight of every bead. When these variables are compared, we find that pes11 has higher values than the other beads (Fig. 11, Table 1), and that the beads from Provença shows up slightly bigger and aspherical than the ones from Pessegueiro II.

As can be seen in figure 11, pes11 sample is much bigger than the rest of the assemblage and has a cylindrical or barrel shape, defined as width/height<1 (sensu Villalobos García 2015). It can also be derived from this figure 11 and following Villalobos García (2015) that the assemblage accounts for three primary shapes, discoidal (54%), aspherical (42%) and cylindrical (4%).

As for beads' colour it can be seen in figure 12 that green hues are heterogeneous (h) and not very pure having a low saturation ( $C_{max}=21.26$ ). It is also possible to see that there is no difference in raw material choice between both tombs, as Provença and Pessegueiro II green beads have similar colour values and therefore organoleptic properties.

## 5. Discussion

Odriozola *et al.* (2016c) have recently proposed that from ~ 2500 BC onwards variscite use began to decline, but not in favor of other greenstones, the use of which had already declined in favour of variscite (Villalobos García 2012). Rather, this coincides with increased availability of copper-based metals (Murillo-Barroso and Montero Ruiz 2012), and new 'exotic' resources such as Asian and African Ivory (Schuhmacher *et al.* 2009; Schuhmacher 2012), Baltic and Sicilian amber (Murillo-Barroso and Martín-Torres 2012). However, a residual use of greenstone for body ornamentation continues to exist. Several examples of greenstone use for body ornamentation can be found on Las Minitas, Castillo de Alange (C/ Umbria 55) or Fuente Álamo during 2<sup>nd</sup> millennium BC (Table 2, Fig. 13). Albeit Argar necropolis accounts for the largest set of green beads, c. 1085 (Costa *et al.* 2011), it is difficult to state to which extent the use of non-variscite

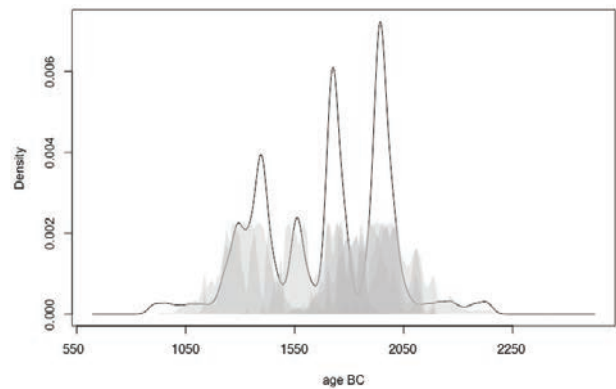

Fig. 13 - Estimate of activity levels on Bronze Age non-variscite greenstone bead consumption (full Bayesian Gaussian mixture model fit to the radiocarbon dates on table 2).

stones may be related to the exhibition of power during social action. Non-variscite beads are no longer made of rare or 'exotic' raw materials, instead they are made of mundane local raw materials as can be exemplified on the use of micas, serpentines, clinochlores (Odriozola *et al.* 2016c). The consumption pattern of greenstones for body ornamentation resembles the pattern observed for the 5<sup>th</sup>-4<sup>th</sup> millennia BC, where a more diversified consumption is recorded, than the 3<sup>rd</sup> millennium BC pattern with a consumption focused on variscite-like minerals (Odriozola *et al.* 2016c).

## 6. Petrological and mineralogical provenance

From the regional geological point of view, we believe that the source of the major lithological artifacts, including body ornaments, is the Cercal Palaeozoic structure (Oliveira, 1984). The north-south aligned Palaeozoic structure of Cercal do Alentejo is one of the major geomorphological structures (Fig. 14). From the Roman times until the present days, it has been exploited for its iron, manganese, copper, lead, zinc, gold and silver in mines that belong to the so called Iberian Pyrite Belt (Munhá, 1983). Lithologically, it is mainly a felsic volcano-clastic outcrop with some amphibolites and chloritic veins





Fig. 14 - Geological map of the Alentejo Coast, with Serra do Cercal structure. In green and red, outcrops that could be used to exploit raw materials for greenstone beads production (modified from Oliveira, 1984).

from a tectono-metamorphic complex structure at the green schist facies composed by a small gossan (iron hat) area with jasper and chert intercalations. Furthermore, minor ultramafic veins (serpentine) could be detected in the open pit zone.

The anticline Cercal stratigraphic sequence begins with a rio-dacitic (felsic) succession (St. Luis formation), at the base, and it is composed by the mafic and locally small amounts of ultramafic lithologies, at the top of the sequence (Carvalho, 1971, 1976, 1985; Albardeiro and Costa, 1988). The occurrence of biotite/phlogopite minerals, as artifacts, could be either explained by the vicinity of Cercal structure or by some phyllosilicates hydrothermal veins at the sienite Sines massif.

## 7. Conclusions

The beads from Pessegueiro II and Provença necropolis had been worked out of regional raw materials, most likely coming from the geological structure of Serra do Cercal (micas and ultramafic derived serpentine), some 20/21 Km away from the necropolis of Pessegueiro and Provença. This pattern can be seen in other 2<sup>nd</sup> millennium BC necropolis in SW Iberia, suggesting a change in greenstone personal ornament consumption patterns, that for the 3<sup>rd</sup> millennium BC was focused on variscite-like minerals. If the studied greenstone beads of the necropolis of Sines region in a first glance could hardly be considered prestigious items concerning its raw material, they were indeed included in the most qualified grave good sets of these cemeteries. In fact, in both cemeteries, greenstone beads appeared associated with silver and gold adornments, artefacts very scarce in the Middle Bronze Age burials of Southwest Iberia. This must be highlighted in the scenario of cemeteries mostly with a strong paucity of funerary offerings (Soares and Tavares da Silva, 2016) and with a huge differentiation between the richest and the poorest graves. Asymmetries are also noticeable under the common typology of the graves, namely in size differences, architectural features, the deceased's position inside the funerary space organisation. This evidence can be interpreted as the result of a hierarchical social structure, where inequality was quite sharp even inside a local community, probably dominated by a leading family headed by a charismatic leader. The presence of rich children graves in the Southwest Middle Bronze Age (Soares and Tavares da Silva, 2016) implies a trend towards increasing social complexity, since status seems to be inherited (not acquired in life), as in state societies. Hence, the power legitimation does not need the exhibition of knowledge and wealth, as in Chalcolithic societies. But the general tendency in southern Iberian Middle-Late Bronze Age towards the establishment of a power structure where ruling functions were obtained via inheritance is not enough to reconstruct a clear picture of their regionalisms. In what concerns the Southwest, it is possible that it have been a domi-

nated periphery of the early state of El Argar (Earle, 1997; Gailey and Patterson, 1988; Garcia Sanjuan, 1999; Soares and Tavares da Silva, 2016). In the archaeological record it is hard to identify features that can indicate signs of the proposed asymmetric core-periphery interaction between the Southwest and El Argar. Trying to achieve material expressions for our statement, we chose the emulation mechanism. It could play a central role in the ideological process of unequal interactions. Several aspects of material culture (such as metallurgy) (Valério *et al.*, 2014), funerary rituals, and the close spatial relation between necropolis and settlement seem to reveal a cultural influence from El Argar (Arteaga, 1992; Cámara and Molina, 2011). Greenstone beads although in regional raw materials could have been subject to a restricted access probably by symbolic reasons in the proposed scenario of emulation as a way of ideological feeding of core-periphery relations. The high concentration of greenstones beads (mostly serpentines) in the necropolis of El Argar should also be noted (Caramé *et al.*, 2011).

## 8. References

- ALBARDEIRO, L. & COSTA, A. (1998) - *Projec-to de Prospeccão de S. Luís. Rel. Técnico Área de Odemira, 1º Sem. 98* – Emp. Mineira da Serra do Cercal, Arq. Beja LNEG.
- ARTEAGA, O. (1992) - Tribalización, Jerarquización y Estado en el territorio de El Argar. *SPAL*, 1, p. 179-208.
- BALDELLOU, V.; UTRILLA MIRANDA, P. & GARCÍA-GAZÓLAZ, J. (2012) - Variscita de Can Tintorer en el Neolítico Antiguo del Valle Medio del Ebro. In *Actes Xarxes al Neolític*. Barcelona: Museu de Gavà, p. 307-314
- CÁMARA, J. A. & MOLINA, F. (2011) - Jerarquización social en el mundo Argárico (2000-1300 aC). *Quaderns de prehistòria i arqueologia de Castelló* 29, p. 77-104.
- CAMPANO LORENZO, A.; RODRIGUEZ MARCOS, J. A. & SANZ MÍNGUEZ, C. (1985) - Apuntes para una primera valoración de la explotación y comercio de la variscita en la Meseta Norte. *Anuario del Instituto de Estudios Zamoranos “Florián de Ocampo”*, p. 13-22.
- CARVALHO, D. (1971) - *Jazigos de Fe-Mn da região Cercal-Odemira. Principais Jazigos Mine-rais do Sul de Portugal* (Livro-Guia nº4), p. 65-73.
- CARVALHO, D. (1976) - Considerações sobre o vulcanismo da região de Cercal-Odemira. Suas relações com a Faixa Piritosa. *Com. SGP*, T. LX, p. 215-238.
- COSTA CARAMÉ, M. E.; GARCÍA SANJUAN, L.; MURILLO-BARROSO, M.; PARRILLA GIRÁLDEZ, R. & WHEATLEY D. W. (2011) - Artefactos elaborados en rocas raras en los contextos funerários del IV-II milénios cal ANE en el Sur de España: una revisión. *Menga. Revista de Prehistoria de Andalucía*, 1, p. 253-293.
- DEER, W. A.; HOWIE, R. A. & ZUSSMAN, J. (1992) - *An introduction to the rock forming minerals*, 2 edición. Pearson, Harlow.
- DOMINGUEZ BELLA, S. (2004) - Variscite, a prestige mineral in the Neolithic-Aeneolithic Europe. Raw material sources and possible distribution routes. *Slovak Geological Magazine* 10, p. 147-152.
- DOMINGUEZ BELLA, S. (2012) - Archaeomineralogy of prehistoric artifacts and gemstones. In HERRERO J. M. & VENDRELL-SAZ, M. (eds), *Archaeometry and Cultural Heritage: the Contribution of Mineralogy*. Sociedad Española de Mineralogía. España: Museo Geominero del Instituto Geológico y Minero de España, p. 5-28.
- EARLE, T. (1997) - *How chiefs come to power. The political economy in Prehistory*. Stanford: Stanford University Press.
- FÁBREGAS VALCARCE, R. (1991) - *Megalitismo del Noroeste de la Península Ibérica. Tipología y se-*

*cuencia de los materiales líticos*. Madrid: Aula Abierta. Universidad Nacional de Educación a Distancia.

FERNANDES, T. M. (2009) - Anexo I- Monumento II do Pessegueiro (Sines) - Estudo antropológico. In C. TAVARES DA SILVA & J. SOARES, Práticas funerárias no Bronze Pleno do Litoral Alentejano: o Monumento II do Pessegueiro. *Estudos Arqueológicos de Oeiras*, 17, p. 389-420.

FERREIRA, O. DA VEIGA (1953) - Os artefactos pré-históricos de calaite e sua distribuição em Portugal. *Arqueologia e História*, V, p. 85-93.

FLORES RAÚL (2011) - El yacimiento de Humanejos (Parla, Madrid). In BLASCO BOSQUED M. C.; LIESAU VON LETTOW-VIRBECK, C. & RÍOS, P. (eds), *Yacimientos calcolíticos con campaniforme de la región de madrid: nuevos estudios*. Madrid, p. 9-16.

GAILEY, C. W. & PATTERSON, T. C. (1988) - State formation and uneven development. In J. GLEDHILL; B. BENDER & M. T. LARSEN (eds.), *State and Society: The Emergence and Development of Social Hierarchy and Political Centralization*. One World Archaeology Series, 4. Londres: Unwin Hyman, p. 77-90.

GARCÍA SANJUÁN, L. (1999) - *Los orígenes de la estratificación social. Patrones de desigualdad en la Edad del Bronce del Suroeste de la Península Ibérica (Sierra Morena Occidental c. 1700- 1100 a.n .e./2100-1300 A.N.E.)*. BAR International Series 823.

GOMES, M. V. (2015) - *The Vale da Telha necropolis (Aljezur) in the context of the Southwest Iberian Bronze Age*. Lisboa: Instituto de Arqueologia e Paleociências da Universidade Nova de Lisboa.

GUITÁN RIVERA, F. & VÁZQUEZ-VARELA, J. M. (1975) - Análisis radiográfico de cuentas de calaíta gallegas. *Boletín de la Comisión de Monumentos de Lugo* 9, p. 187-188.

MUNHÁ, J. (1983) - Hercynian magmatism in the

Iberian Pyrite Belt. In SOUSA, M. J. L. & OLIVEIRA, J. T., (Eds.) - *The Carboniferous of Portugal* (Memórias dos Serviços Geológicos de Portugal 29), p. 39-81.

MUÑOZ AMILIBIA, A. M. (1965) - *La Cultura neolítica catalana de los "sepulcros de fosa"*. Barcelona: Universidad de Barcelona.

MURILLO-BARROSO, M. & MARTINÓN-TORRES, M. (2012) - Amber Sources and Trade in the Prehistory of the Iberian Peninsula. *European Journal of Archaeology*, 15 (2) p. 187-216.

MURILLO-BARROSO, M. & MONTERO RUIZ, I. (2012) - Copper Ornaments in the Iberian Chalcolithic: Technology versus Social Demand. *Journal of Mediterranean Archaeology*, 25, p. 53-73.

ODRIOZOLA, C. P.; BENÍTEZ DE LUGO ENRICH, L.; VILLALOBOS GARCÍA, R. *et al.* (2016a) - Personal body ornamentation on the Southern Iberian Meseta: An archaeomineralogical study. *Journal of Archaeological Science: Reports* 5, p. 156-167. doi: 10.1016/j.jasrep.2015.11.021.

ODRIOZOLA, C. P. & GARCÍA SANJUÁN, L. (2012) - Las cuentas de collar de piedra verde de Matarrubilla (Valencina de la Concepción, Sevilla). In GARCÍA SANJUÁN, L.; VARGAS JIMÉNEZ, J. M. & HURTADO PÉREZ, V.; ET AL. (eds), *El asentamiento prehistórico de Valencina de la Concepción (Sevilla). Investigación y tutela en el 150 aniversario del descubrimiento de la Pastora*. Sevilla: Universidad de Sevilla, p. 485-494.

ODRIOZOLA, C. P.; LINARES CATELA, J. A. & HURTADO, V. (2010) - Variscite Source and Source Analysis: Testing Assumptions at Pico Centeno (Encinasola, Spain). *Journal of Archaeological Science* 37, p. 3146-3157.

ODRIOZOLA, C. P.; VILLALOBOS GARCÍA, R.; BUENO RAMÍREZ, P.; ET AL (2016b) - Late Prehistory body ornament, Exchange and social dynamics in the middle Tagus basin. In *Key resources in Archaeology*. University of Tubingen.



- ODRIOZOLA, C. P.; VILLALOBOS GARCÍA, R.; BURBIDGE, C. I.; ET AL (2016c) - Distribution and chronological framework for Iberian variscite mining and consumption at Pico Centeno, Encinasola, Spain. *Quaternary Research* 85:159–176. doi: 10.1016/j.yqres.2015.11.010
- OLIVEIRA, J. T. (Coord.) (1984) - *Carta Geológica de Portugal na Escala 1/200 000. Notícia Explicativa da Folha 7*. Serviços Geológicos de Portugal. Lisboa.
- ROBERTS, W. L.; CAMPBELL, T. J. & RAPP, G. R. (1990) - *Encyclopedia of minerals*.
- SANTOS, M. F.; SOARES, J. & TAVARES DA SILVA, C. (1974) - Necrópole da Provença (Sines). Campanha de escavações de 1972. *Arqueologia e História*. Lisboa, 5, p. 69-99.
- SANTOS, M. F.; SOARES, J. & TAVARES DA SILVA, C. (1975) - A necrópole da Idade do Bronze da Provença (Sines, Portugal): Nota preliminar. *Actas del XIII Congreso Nacional de Arqueología*. Zaragoza, p. 417-432.
- SCHUBART, H. (1975) - *Die Kultur der Bronzezeit im Südwesten der Iberischen Halbinsel* (Madriдер Forschungen, 9). Berlin: Walter de Gruyter.
- SCHUHMACHER, T. X. (2012) - *Faszikel 2: Chalkolithische und Frühbronzezeitliche Elfenbeinobjekte auf der Iberischen Halbinsel*. Verlag Philipp Von Zabern, Taravilla.
- SCHUHMACHER, T. X. ; CARDOSO, J. L. & BANERJEE, A. (2009) - Sourcing african ivory in Chalcolithic Portugal. *Antiquity* 83, p. 983-997.
- SOARES, A. M. (1994) - O Bronze do Sudoeste na margem esquerda do Guadiana. As necrópoles do concelho de Serpa. *Actas das V Jornadas Arqueológicas*. Lisboa: Associação dos Arqueólogos Portugueses, p. 179-197.
- SOARES, J. & TAVARES DA SILVA, C. (1995) - O Alentejo Litoral no contexto da Idade do Bronze do Sudoeste Peninsular. *A Idade do Bronze em Portugal: Discursos de Poder*. Lisboa: Instituto Português de Museus, p. 136-139.
- SOARES, J. & TAVARES DA SILVA, C. (1998) - From the collapse of the chalcolithic mode of production to the development of the Bronze Age societies in the south-west of Iberian peninsula. In S. O. JORGE (ed.), *Existe uma Idade do Bronze Atlântico?* (Trabalhos de Arqueologia, 10). Lisboa: Instituto Português de Arqueologia, p. 231-245.
- SOARES, J. & TAVARES DA SILVA, C. (2016) - Bronze Médio do Sudoeste Ibérico. Indicadores de Complexidade Social. In A. C. SOUSA; A. CARVALHO & C. VIEGAS (eds.), *Terra e Água. Escolher sementes, invocar a Deusa. Estudos em Homenagem a Victor S. Gonçalves*. (Estudos & Memórias, 9). Lisboa: Centro de Arqueologia da Universidade de Lisboa, p. 359-384.
- TAVARES DA SILVA, C. & SOARES, J. (1979) - O Monumento I da necrópole do Bronze do Sudoeste do Pessegueiro (Sines). *Setúbal Arqueológica*, V, p. 121-157.
- TAVARES DA SILVA, C. & SOARES, J. (1981) - *Pré-história da área de Sines*. Lisboa: Gabinete da Área de Sines.
- TAVARES DA SILVA, C. & SOARES, J. (2009) - Práticas funerárias no Bronze Pleno do Litoral Alentejano: o Monumento II do Pessegueiro. *Estudos Arqueológicos de Oeiras*, 17, p. 389-420.
- VALÉRIO, P.; SOARES, A. M. M.; ARAÚJO, M. F.; SILVA, R. J. C.; PORFÍRIO, E. & SERRA, M. (2014) - Arsenical copper and bronze in Middle Bronze Age burial sites of Southern Portugal: the first bronzes in Southwestern Iberia. *Journal of Archaeological Science*, 42, p. 68–80.
- VÁZQUEZ VARELA, J. M. (1975) - Cuentas de “calaita” en la Península Ibérica: datos para la revisión del problema. *Gallaecia*, p. 25-30.
- VILLALBA, M. J.; EDO I BENAIGES, M. & BLASCO, A. (2001) - La callaïs en Europe du Sud-

Ouest. État de la question. In LE ROUX C-T (ed), *Du monde des chasseurs à celui des métallurgistes*. Université Rennes I, p. 267-276.

VILLALOBOS GARCÍA, R. (2012) - Adornos exóticos en los sepulcros tardoneolíticos de la Submeseta Norte Española. El ejemplo de Las Tuerces como nodo de una red descentralizada de intercambios. In *Actes Xarxes al Neolític*. Gavà (Barcelona): Museu de Gavà, p. 265-271.

VILLALOBOS GARCÍA, R. (2015) - *Análisis de las transformaciones sociales en la prehistoria reciente de la Meseta Norte Española (milenios VI-III CAL A.C.) a través de empleo de la variscita y otros minerales verdes como artefactos sociotécnicos*. Universidad de Valladolid, Facultad de Filosofía y Letras Facultad de Filosofía y Letras.